

Accessories and spare parts

Fixed grip for hand shower

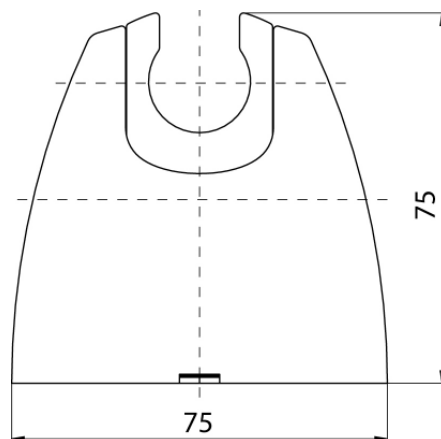

Code	EAN13
2449390	5907451924334

Product usage:

For bath and shower mixers of VALVEX production

Type:

Fixed grips

Guarantee:

2-year

Technical data/Operating parameters:**Used materials:**

ABS plastic

Finish:

chrome