

Pressure reducers CETUS

Shot blasted pressure reducer (female-female version)

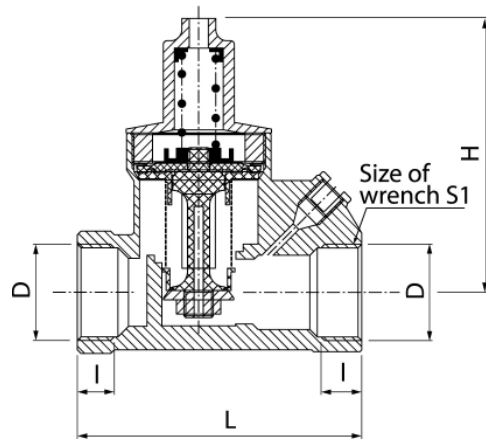

DN	Code	Dimensions						EAN13
		Size	D	L	I	H	S	
15	1900300	1/2"	G1/2	68	11,5	70	27	5907451941706
20	1900310	3/4"	G3/4	71	12	75	31,5	5907451941713

Product usage:

For use in with cold and hot water systems in buildings

Type:

Pressure reducers

Guarantee:

25-year

Technical data/Operating parameters:

Max pressure: 1,6 MPa,
Max temperature: 75°C

Used materials:

body, knurled nut, setting screw, cover: brass;
spring button, ring, spring: steel;
plug: ABS;
valve insert: brass, steel;
seal: NBR and EPDM rubber

Finish:

body, knurled nut, setting
screw, cover: brass